

## Residential Air Conditioning

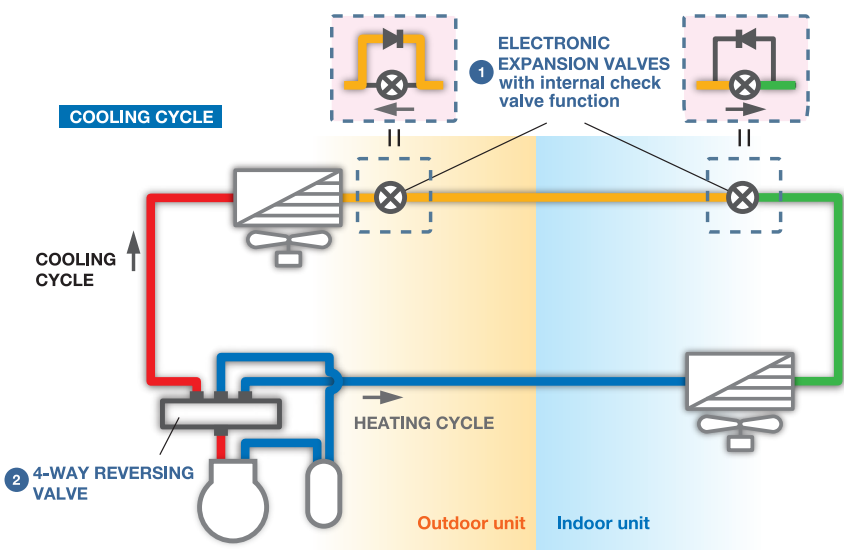

## Commercial Air Conditioning

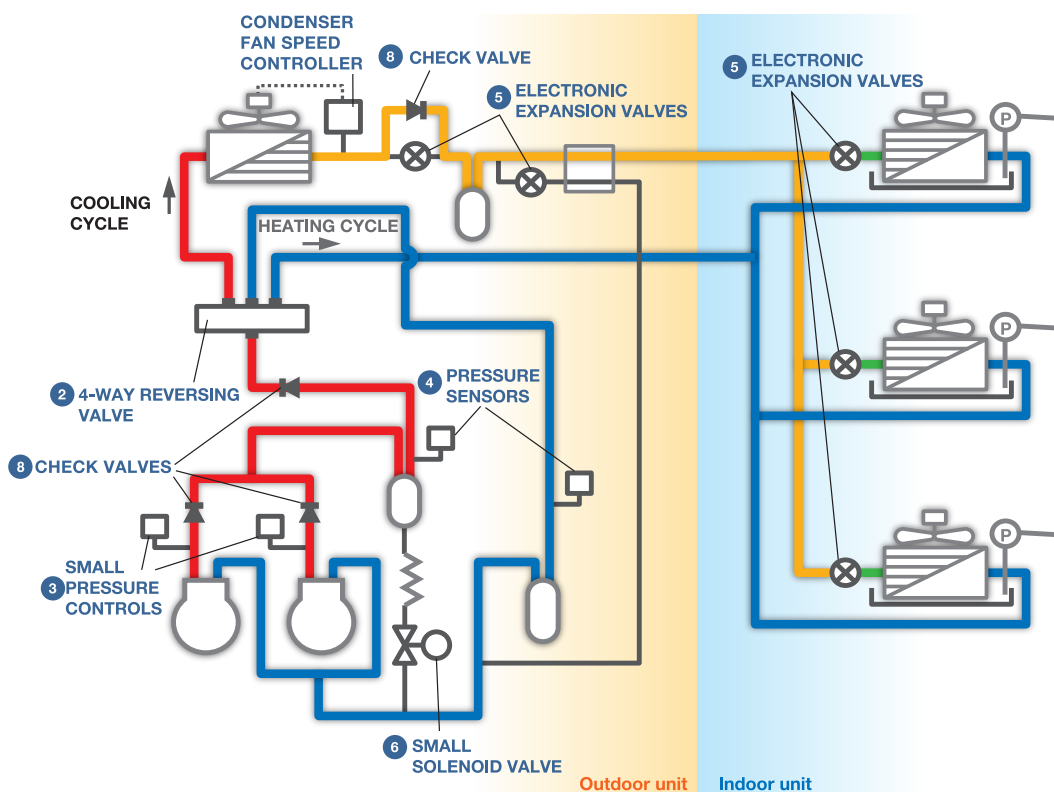

## Heat Pump Water Heating

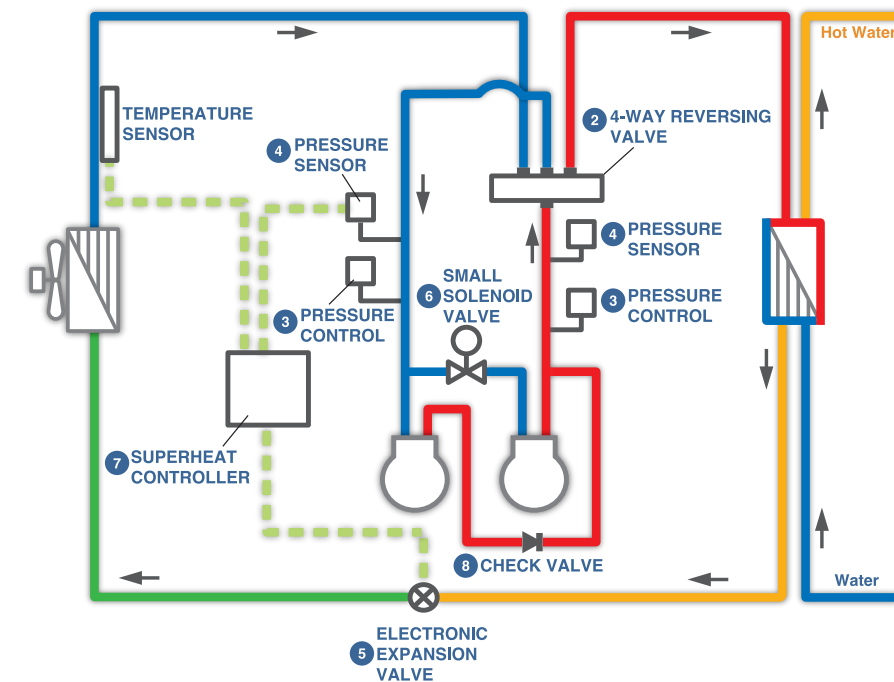

### 1 | ELECTRONIC EXPANSION VALVES with internal check valve function

Type **UKV-F**

- [Supply Voltage] 12V.DC
- [Max. Working Press.] 623psi{4.3MPa}
- [Capacity] 3.4 to 7.6U.S.R.T. {12.1 to 26.6kW}(R410A)
- [Fluid Temp.] -22 to 158°F {-30 to 70°C}
- [Actuator] Stepper motor

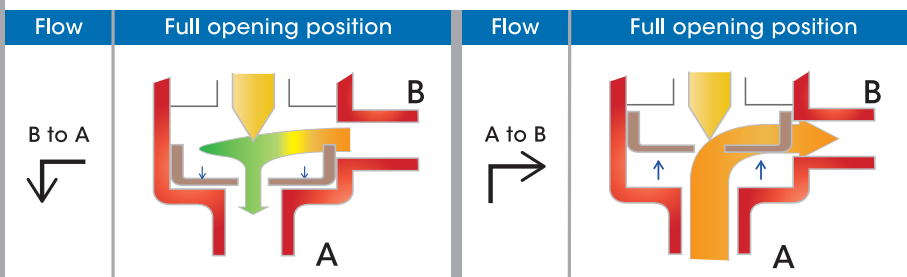

### 7 | SUPERHEAT CONTROLLERS

Type **XNE**

- [Supply Voltage] 24V.AC / 24V.DC
- [Temp. Range] -22 to 86°F {-30 to 30°C}
- [Ambient Temp.] 32 to 122°F {0 to 50°C}
- [Power Consumption] 15VA or less
- [Control Method] PID Control (pressure-temperature type)



### 2 | 4-WAY REVERSING VALVES

Type **STF**

- [Capacity] 0.5 to 102.0U.S.R.T. {1.8 to 360kW}(R410A)
- [O.P.D.] 44 to 449 psi {0.3 to 3.1MPa}
- [Fluid Temp.] -4 to 248°F {-20 to 120°C}
- 4 to 266°F {-20 to 130°C} (STF-20U27G to 60U9G)

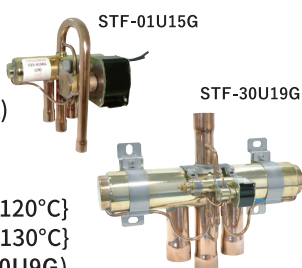

### 4 | PRESSURE SENSORS

Type **NSK**

- [Press. Range] 0 to 725psi {0 to 5.0MPa}, etc
- [Output] 0.5 to 4.5V.DC / 4 to 20mA
- [Supply Voltage] 5V.DC / 7 to 35V.DC
- [Connections] 1/4" Flare, Solder 1/8" NPT



### 6 | SMALL SOLENOID VALVES

Type **VPV/TEV-S**

- [Max. Working Press.] 623psi {4.3MPa}
- [Fluid Temp.] -22 to 248°F {-30 to 120°C}
- [Connections] 1/4" to 1/2" Solder
- [Cv Value] 0.06 to 3.0 : VPV 0.037 to 0.09 : TEV-S

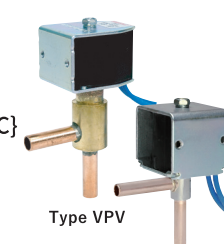

Low power consumption Type VPV-S

### 8 | CHECK VALVES

Type **BCV/UCV**

- [Max. Working Press.] 609psi{4.2MPa}
- [Fluid Temp.] -22 to 248°F {-30 to 120°C}
- [Connections] BCV 1/4" to 1" Solder UCV 1/2" to 7/8" Solder
- [Cv Value] BCV 0.33 to 8 UCV 1/2" : 4.5, 5/8" : 4.5, 7/8" : 9, 1" : 9



### 3 | SMALL PRESSURE CONTROLS

Type **ACB/LCB**

- [Range] 15 to 653psi {0.1 to 4.5MPa}(setting) ACB : 101 to 653psi, LCB : 15 to 101psi
- [Contact Functions] SPST · SPDT
- [Contact Capacity] 250V.AC 1 to 4A
- [Connections] 1/4" Flare, Solder
- High durability types (500K times) are also available



### 5 | ELECTRONIC EXPANSION VALVES

Type **UKV-S/UKV-SH**

- [Supply Voltage] 12V.DC
- [Max. Working Press.] 623psi{4.3MPa}
- [Capacity] 0.5 to 39.6U.S.R.T. {1.8 to 139.2kW}(R410A)
- [Fluid Temp.] -22 to 158°F {-30 to 70°C}
- [Actuator] Stepper motor



### - | PRESSURE REGULATING VALVES

Type **DPR**

- Discharge Regulation
- [Max. Working Press.] 420psi {2.9MPa}
- [Range] 142 to 355psi {0.98 to 2.45MPa}
- Liquid Seal Protection
- [Max. Working Press.] 609psi {4.2MPa}
- [Range] 580psi {4.0MPa}



### - | CHANGE-OVER VALVES

Type **RKV**

- [Supply Voltage] 12V.DC
- [Max. Working Press.] 435psi {3.0MPa}
- [Port Size] φ1.0
- [Fluid Temp.] -22 to 149°F {-30 to 65°C}
- [Actuator] Stepper motor

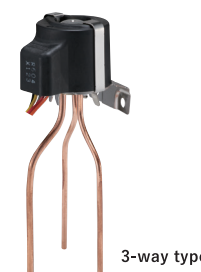

3-way type